

YAMAHA T-960II

*Natural Sound AM/FM Stereo Tuner
Computer Servo Locked Synthesizer Tuning System
DC NFB PLL Multiplex Demodulator
AM/FM 10-Station Random-Access Preset Tuning
Precise Digital Frequency Readout, Auto DX*



OWNER'S MANUAL

Thank you for purchasing the YAMAHA T-960II AM/FM stereo tuner.

CONTENTS	
CAUTION: READ THIS BEFORE OPERATING YOUR T-960II	1/2
CONNECTION DIAGRAM	3
CONNECTIONS	4
FRONT PANEL PARTS AND FUNCTIONS	5/6
MULTIPATH INTERFERENCE	6
RECEIVING FM/AM BROADCASTS	7
INITIAL STATION SET	7
USING THE STATION CARDS	8
SPECIFICATIONS	8
TROUBLESHOOTING	9
BLOCK DIAGRAM	10

IMPORTANT

Please record the serial number of your unit in the space below.

Model: T-960II

Serial No.:

The serial number is located on the rear of the chassis.
Retain this Owner's Manual in a safe place for future reference.

WARNING

To prevent fire or shock hazard, do not expose this appliance to rain or moisture.

T-960II

CAUTION (PREPARED IN ACCORDANCE WITH UL STANDARD 1270)

1

Read Instructions — All the safety and operating instructions should be read before the appliance is operated.

2

Retain Instructions—The safety and operating instructions should be retained for future reference.

3

Heed Warnings—All warnings on the appliance and in the operating instructions should be adhered to.

4

Follow instructions—All operating and other instructions should be followed.

5

Water and Moisture—The appliance should not be used near water—for example, near a bathtub, washbowl, kitchen sink, laundry tub, in a wet basement, or near a swimming pool, etc.

6

Carts and Stands—The appliance should be used only with a cart or stand that is recommended by the manufacturer.

7

Wall or Ceiling Mounting—The appliance should be mounted to a wall or ceiling only as recommended by the manufacturer.

8

Ventilation—The appliance should be situated so that its location or position does not interfere with its proper ventilation. For example, the appliance should not be situated on a bed, sofa, rug, or similar surface that may block the ventilation openings; or, placed in a built-in installation, such as a bookcase or cabinet that may impede the flow of air through the ventilation openings.

9

Heat—The appliance should be situated away from heat sources such as radiators, stoves, or other appliances that produce heat.

10

Power Sources—The appliance should be connected to a power supply only of the type described in the operating instructions or as marked on the appliance.

11

Grounding or Polarization—The precautions should be taken so that the grounding or polarization means of the appliance is not impeded.

12

Power-Cord Protection—Power-supply cords should be routed so that they are not likely to be walked on or pinched by items placed upon or against them, paying particular attention to cords at plug, convenience receptacles, and the point where they exit from the appliance.

13

Cleaning—The appliance should be cleaned only as recommended by the manufacturer.

14

Nonuse Periods—The power cord of the appliance should be unplugged from the outlet when left unused for a long period of time.

15

Object and Liquid Entry—Care should be taken so that objects do not fall into and liquids not spilled into the enclosure through openings.

16

Damage Requiring Service—The appliance should be serviced by qualified service personnel when:

- A. The power-supply cord or the plug has been damaged; or
- B. Objects have fallen, or liquid has been spilled into the appliance; or
- C. The appliance has been exposed to rain; or
- D. The appliance does not appear to operate normally or exhibits a marked change in performance; or
- E. The appliance has been dropped, or the enclosure damaged.

17

Servicing—The user should not attempt to service the appliance beyond that described in the operating instructions. All other servicing should be referred to qualified service personnel.

18

Power Lines—An outdoor antenna should be located away from power lines.

19

Outdoor antenna grounding—If an outside antenna is connected to the tuner, be sure the antenna system is grounded so as to provide some protection against voltage surges and built up static charges. Section 810 of the National Electrical Code, ANSI/NFPA No. 70—1978, provides information with respect to proper grounding of the mast and supporting structure, grounding of the lead-in wire to an antenna discharge unit, size of grounding conductors, location of antenna-discharge unit, connection to grounding electrodes, and requirements for the grounding electrode.

Example of Antenna Grounding as per National Electrical Code Instructions

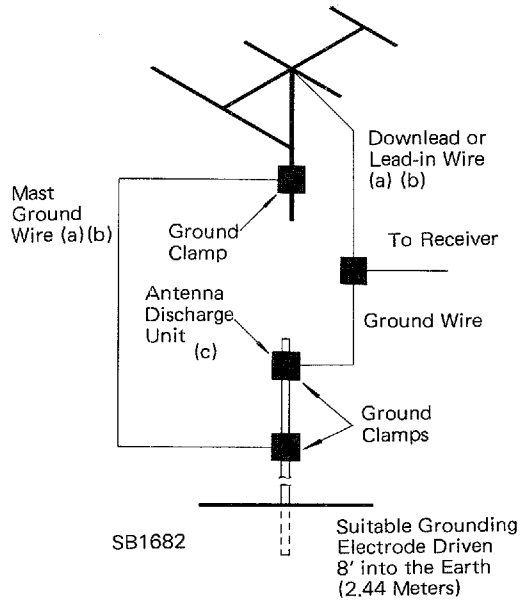

(a)
Use No. 10 AWG copper or No. 8 AWG aluminum or No. 17 AWG copper-clad steel or bronze wire or larger as ground wires for both mast and lead-in.

(b)
Secure lead-in wire from antenna to antenna discharge unit and mast ground wire to house with stand-off insulators, spaced from 4 feet (1.22 meters) to 6 feet (1.83 meters) apart.

(c)
Mount antenna discharge unit as closely as possible to where lead-in enters house.

CAUTION: READ THIS BEFORE OPERATING YOUR T-960II

1

The T-960II is a sophisticated AM/FM stereo tuner. To ensure proper operation for the best possible performance, please read this manual carefully.

2

Choose the installation location of your T-960II carefully. Avoid placing it in direct sunlight or close to a source of heat. Also avoid locations subject to vibration and excessive dust, heat, cold or moisture. Keep it away from such sources of hum as transformers or motors.

3

Do not open the cabinet as this might result in damage to the set, or electrical shock. If a foreign object should get into the set, contact your dealer.

4

To prevent lightning damage, pull out the power cord and remove the antenna cable in case of an electrical storm.

5

When removing the power plug from the wall outlet, always pull directly on the plug; never yank the cord.

6

Do not use force when using the switches or knobs.

7

When moving the set be sure to first pull out the power plug and remove cords connecting to other equipment.

8

Do not attempt to clean the T-960II with chemical solvent as this might damage the finish. Use a clean, dry cloth.

9

Be sure to read the "troubleshooting" section for advice on common operating errors before concluding that your T-960II is faulty.

10

Keep this manual in a safe place for future reference.

T-960II

CONNECTION DIAGRAM

Be sure to connect the left (L) and right (R) channels consistently from component to component.

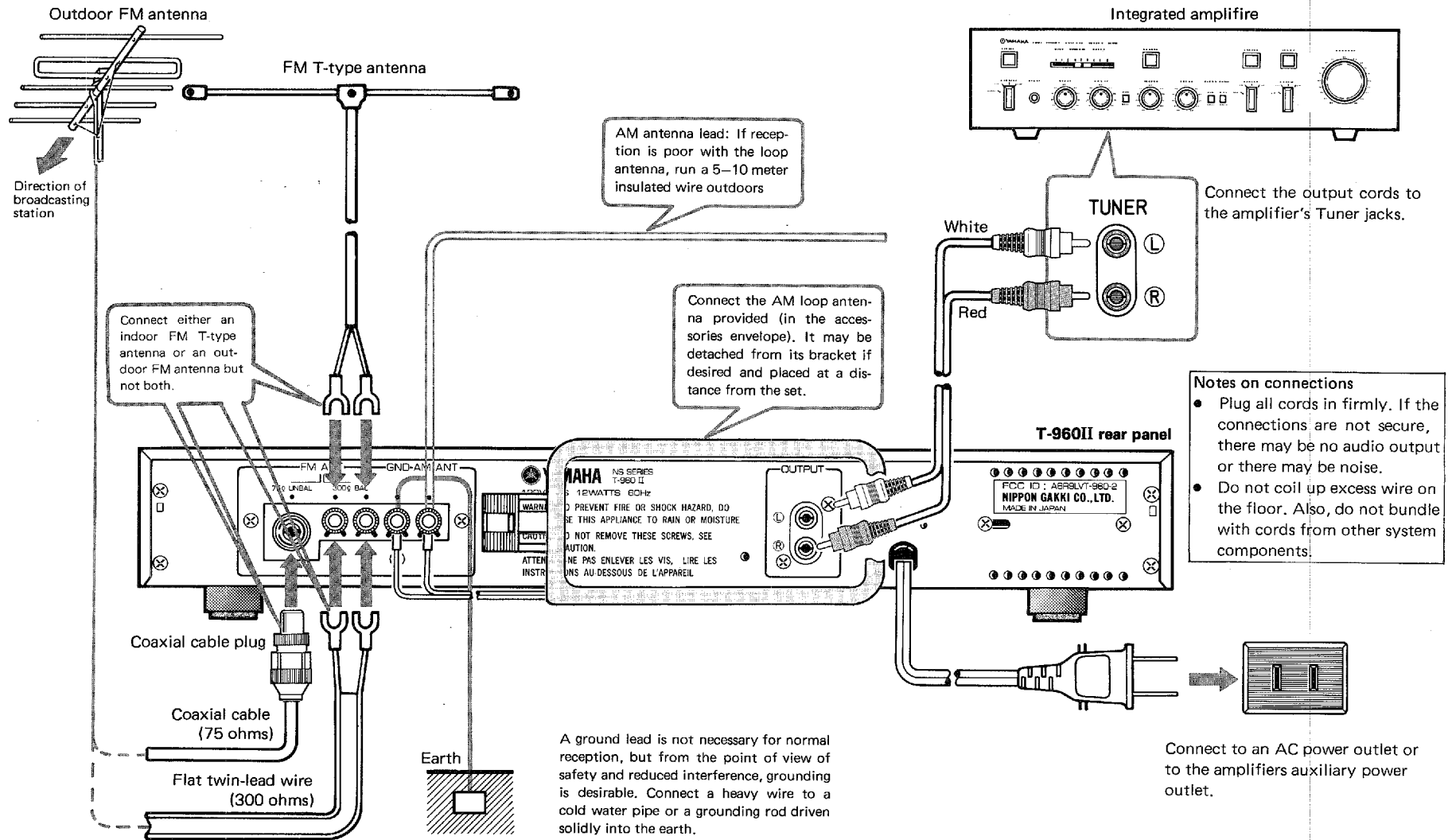

CONNECTIONS

■ CONNECTING THE FM ANTENNA

Choose an FM antenna that is appropriate to the local reception conditions. Consider the distance from the broadcast station and possible interfering objects such as surrounding tall buildings. In cases where there is a strong signal from a local station, a portable T-type antenna is usually adequate. Connect the feeder wire to the 300 ohm terminal, stretch the wire out tight, and turn to obtain optimum reception. Attach to a suitable support such as a wall.

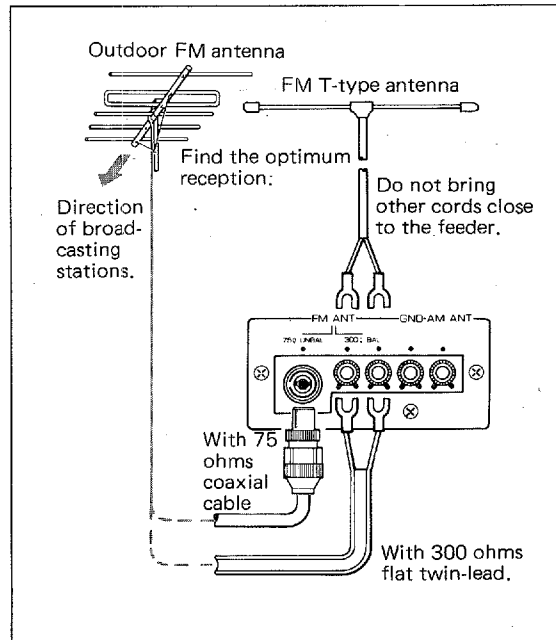

In all but the best reception conditions, an outdoor FM antenna is necessary for best results. Either 300 ohms flat twin-lead wire or 75 ohms coaxial cable may be used. In locations where electrical interference is a problem, coaxial cable is preferable. Refer to the figure for instructions on installing the coaxial cable plug.

Attaching the plug to the coaxial cable

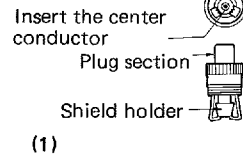

(1) Remove the outer covering of the coaxial cable up to about 23mm from the end, and slide the tightening sleeve over the cable. Insert the center conductor of the coaxial cable into its hole in the plug section, place the shield into the shield holder and plug in.

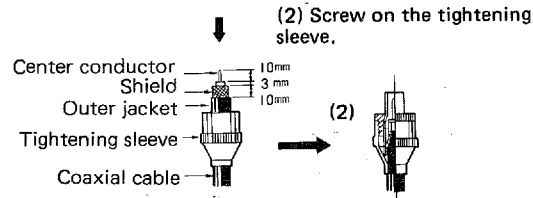

■ CONNECTING THE AM ANTENNA

In many cases it will be possible to get excellent AM reception with the provided AM loop antenna. Attach the antenna leads to the Gnd and AM Ant terminals and rotate the antenna in its bracket for best reception. The loop antenna may also be removed and hung on the wall. If necessary, an outdoor antenna may be used for improved AM reception. Connect a 5-10 meter length of insulated wire to the AM Ant terminal and run it outdoors.

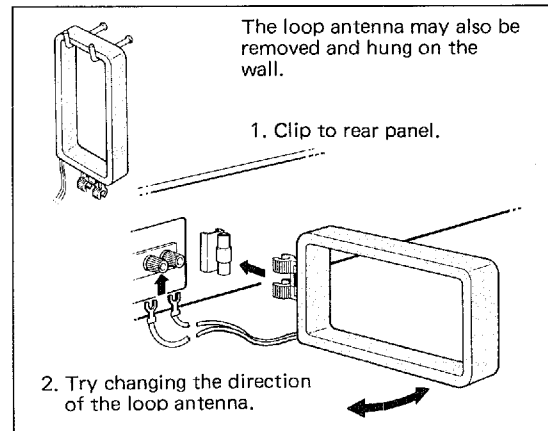

■ NOTE ON FM/AM ANTENNA INSTALLATION

This tuner has both an auto-search type tuning system with 100kHz steps on FM and 10kHz steps on AM and a manual tuning system. Normally, with stations stronger than $10\mu\text{V}$ ($300\mu\text{V/m}$ on AM when using the loop antenna), auto-search tuning can be used to find and tune in stations automatically. Weaker stations may be tuned in with manual step tuning. Extremely weak stations, however, will not be heard due to the action of the muting circuit. In this case, try rechecking the antenna connections and adjusting the location, direction, and height of the antenna to increase the signal strength to a high enough level for proper reception.

■ CONNECTING THE AMPLIFIER

Use the cable supplied to connect from the output jacks to the tuner input jacks of your amplifier, being sure to observe the left and right channel markings. Also make sure that the connections are secure and that the connecting cable is not bundled with the speaker leads or power cord from the amplifier.

Accessories

Please confirm the accessories included.

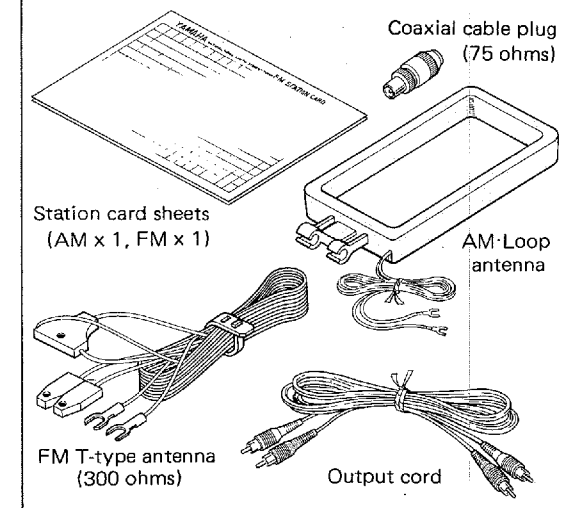

T-960II

FRONT PANEL PARTS AND FUNCTIONS

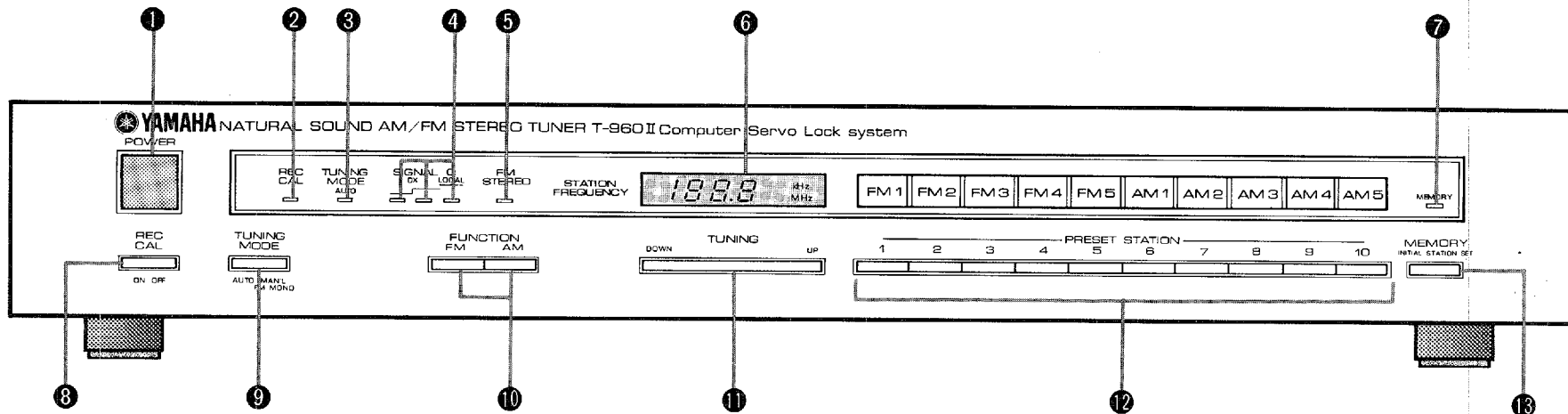

1 POWER SWITCH

When power is turned on illumination lamps above the PRESET STATION button will light, and in a minute tunes in the station selected with INITIAL STATION SET will be turned in. See page 7 for INITIAL STATION SET.

2 REC CAL INDICATOR

This indicator lights to remind you that the REC CAL switch 8 has been turned on.

3 TUNING MODE INDICATOR

The AUTO indicator lights when the TUNING MODE switch 9 is set to AUTO, and remains off when the TUNING MODE switch is set to MAN'L.

4 SIGNAL QUALITY METER

Indicates the strength of the received station. Adjust the height and direction of the antenna for maximum indication. When receiving an FM broadcast, the indicator also

shows the status of the Auto DX circuit. When the strength of the station is enough to light the Local segment of the indicator, there will be no interference and the tuner will employ the wide-bandwidth Local mode for optimum music reproduction accuracy. When the signal is only strong enough to light the DX segments, the tuner switches to high-selectivity DX mode to block interference and provide cleaner reception. Once a station becomes weak enough to cause the tuner to enter DX mode, Local mode will not be entered even if the signal becomes stronger, and the Local indicator segment will not light. Manually detuning the station and tuning it in again will allow the tuner to revert to Local mode if the station is strong enough.

* On AM broadcasts the Auto DX feature is ineffective, and the SIGNAL Q meter only shows signal strength.

5 STEREO INDICATOR

When an FM STEREO broadcast is being received this indicator lights.

6 DIGITAL FREQUENCY READOUT

Shows the frequency of the station tuned in with the TUNING button 11 or the PRESET STATION buttons 12. The FM frequency range is 87.8–108MHz, while the AM frequency range is 516–1614kHz.

7 MEMORY INDICATOR

Lights for about 5 seconds after the MEMORY button 13 is pressed. During this interval the preset memory locations may be programmed.

8 REC CAL SWITCH

This switch provides a signal for setting record levels prior to recording from the tuner. Pressing the switch activates the REC CAL oscillator to send a 333Hz 50% FM modulated signal to the output jacks. This allows the recording level to be set for a "typical" program level regardless of the current level of the broadcast being received. Set the decks record level controls so that the record level meters indicate -6VU-0VU.

* The REC CAL switch takes precedence over all other tuner functions; therefore, it should be left off when not in use.

9 TUNING MODE SWITCH

Sets the Tuning button for either Auto or Manual operation.

- **Auto Position**

The TUNING MODE indicator 6 lights, and the auto-search tuning function of the Tuning button 11 is activated.

- **MAN'L/FM MONO Position**

The TUNING MODE indicator is off, and the manual tuning function of the Tuning button 11 is activated.

10 FUNCTION BUTTONS (AM/FM SELECTOR)

These switches select either FM or AM broadcasts.

- Pressing the FM button selects FM reception and sets the digital frequency display to "MHz".
- Pressing the AM button selects AM reception and sets the digital frequency display to "kHz".

11 TUNING BUTTON

Use this button to tune in broadcast stations.

- **When the TUNING MODE switch 9 has been set to AUTO.**

Pressing the DOWN side of the button scans the broadcast band downwards until a station is encountered, then stops with the station perfectly tuned in (Auto-Search Tuning). Pushing the button again scans progressively lower frequencies until the next station is found. When the bottom of the band is reached, the frequency is set to the top of the band and the scan continues downward. Pressing the Up side of the button scans the band upwards in the same way.

- **When the TUNING MODE switch 9 has been set to MAN'L.**

Pressing the DOWN side of the button scans down the band only as long as the button is held, and pressing the Up side scans upwards as long as the button is held. In either case scanning stops when the button is released. Unlike automatic scanning, attempting to tune beyond the upper or lower limit of the band will cause tuning to stop, without jumping to the other end of the band. Pushing the Tuning button briefly causes the frequency to advance 0.1MHz on FM or 1kHz on AM.

12 PRESET STATION BUTTONS

Use these buttons to select the broadcast station preset with MEMORY button.

A total of 10 stations may be preset into the tuner's MEMORY.

13 MEMORY BUTTON

Pushing this button causes the indicator on the button to light for 5 seconds. Pressing one of the PRESET STATION buttons 12 while the indicator is lit causes the frequency of the station currently tuned in to be memorized.

This button is also used to control the Initial Station Set function. You can preselect the station to be tuned in when power is first turned on. For details refer to page 7.

MULTIPATH INTERFERENCE

Multipath is an effect similar to television ghosting; it distorts the received signal and also causes poor stereo separation and noise. As shown in fig, radio waves which travel directly from the transmitter to the receiving antenna are mixed with waves which reflect off nearby objects such as buildings. Because the path taken by the reflected waves is longer than the direct path, the time required for the waves to arrive at the antenna is also longer. The mixing of the directly received signal and the delayed signal noticeably degrades reception quality. Multipath interference can be greatly reduced by the use of a high-quality directional antenna oriented in the proper direction.

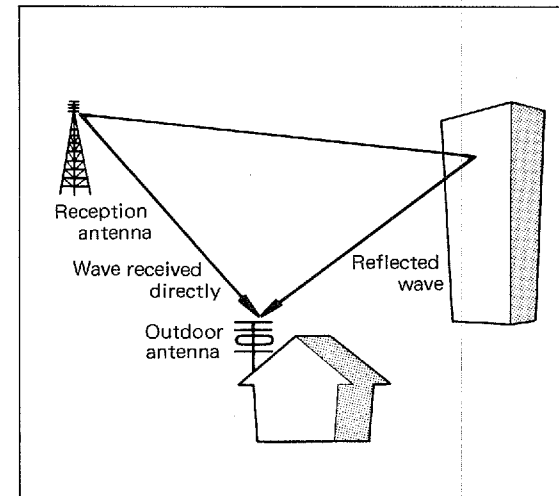

T-960II

RECEIVING FM/AM BROADCASTS

■ AUTO SEARCH Tuning

- 1) Press the FUNCTION button to select FM or AM.
- 2) Set the TUNING MODE switch to "AUTO".
 - * Turning the POWER switch on will automatically be set to "AUTO".
- 3) Press the DOWN or the UP side of the TUNING button. The tuner will automatically scan the band and stop when a station is found. When the station's frequency is locked in, the Signal Q meter will light to show that a station is being received.

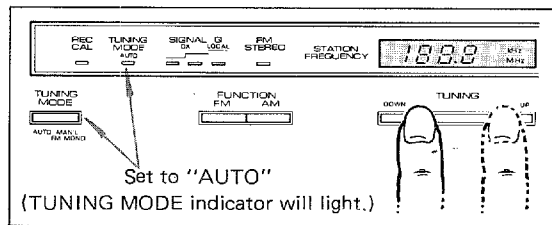

- 4) If the frequency of the desired station has not yet been reached, press the button repeatedly until your station has been tuned in.
 - * If no antenna is connected or when an indoor antenna is being used, there may be no stations strong enough to stop the automatic scan. Set the TUNING MODE switch to MAN'L to stop the scan in this case.

■ MANUAL Tuning

When the signal strength of the desired station is very weak, there are cases when the auto search tuning feature will not be able to find the station. In this case manual tuning should be used.

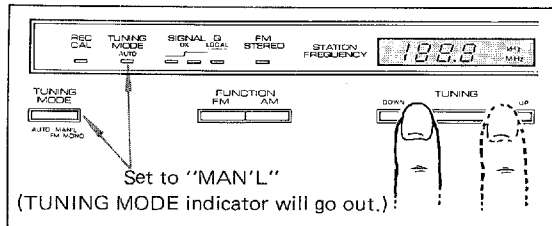

- 1) Press the FUNCTION button to select FM or AM.
- 2) Set the TUNING MODE switch to "MAN'L".
- 3) Press the DOWN or the UP side of the TUNING button. Release the button slightly before the frequency of the desired station is reached, and use light presses of the button to tune the station in exactly. When the station's frequency is locked in the Signal Q meter will indicator will light to show that a station is being received.

■ PRESET Tuning

In addition to the Auto Search Tuning and Manual Tuning functions of the TUNING button, this tuner has PRESET STATION buttons which provide convenient preset tuning. This one-touch tuning method is easier, faster and more precise than ordinary tuning methods.

● Presetting Stations into the Memory

The following example shows how to preset station frequencies into memory 1.

- 1) Tunes in the desired station's frequency with AUTO SEARCH Tuning or MANUAL Tuning.
- 2) Press the MEMORY button, and it will light about 3 seconds.
- 3) While it is lit press the desired button on the PRESET STATION buttons. The station's frequency will be memorized and the MEMORY indicator will go out.

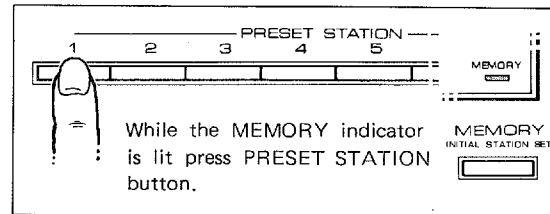

- * When you want to change a previously preset memory, simply repeat the preset procedure given above and the previously memorized frequency will be automatically erased.

● Tuning in a Preset Station

By pressing only PRESET STATION buttons a total of 10 FM and AM stations can be tuned in without having to manually select FM or AM with the FUNCTION buttons.

■ INITIAL STATION SET Feature

You can have the T-960II tune in the station you most often listen to automatically when power is first turned on. This feature is also useful for turning the tuner on with a timer to begin recording an FM or AM broadcast while away.

- 1) Tune in the preset station that you want to listen to (or record) when power is turned on.
- 2) Press the MEMORY button and hold it until its indicator begins to flash. Now, power may be turned off. Now, every time power is turned back on, the selected station will automatically be tuned in.

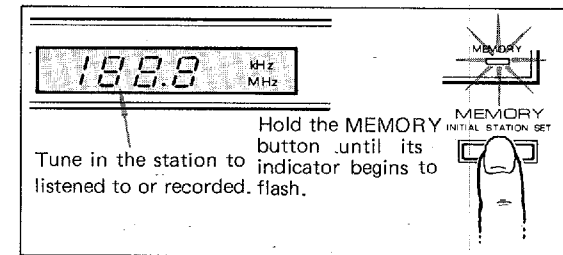

T-960II



Using the Station Cards

Station Cards as shown below come with the T-960II.



The following cards are provided for your use:



... for blank channels



... for a wireless FM mic

Blank station cards are provided for you to fill in according to the particular stations in your area you wish to program into the preset memory. They can be changed at your discretion.

Inserting, replacing station cards:

1. Remove the card holder.

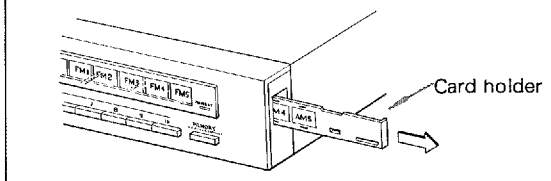

2. Remove the attached card.

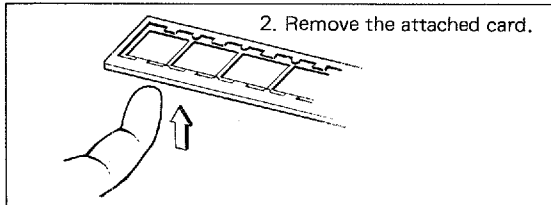

3. After appropriately labelling a station card, remove it from the film sheet and attach it to the card holder.

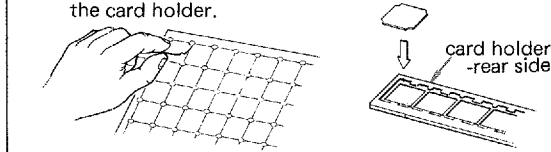

4. Attach the card holder to the tuner.

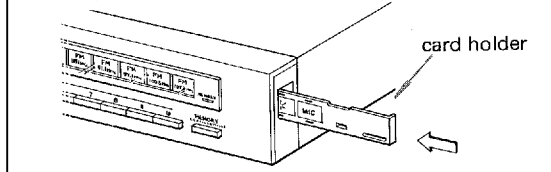

SPECIFICATIONS

FM SECTION

Tuning Range	87.8 to 108 MHz
50 dB Quieting Sensitivity (IHF) Mono	3.5 μ V (16.1 dBf)
Stereo	40 μ V (37.2 dBf)
Usable Sensitivity Mono (98 MHz 30 dB Quieting)	1.8 μ V (300 ohms) 10.3 dBf
	0.9 μ V (75 ohms) 10.3 dBf
Image Response Ratio (98 MHz)	70 dB
IF Response Ratio (98 MHz)	80 dB
Spurious Response Ratio (98 MHz)	80 dB
AM Suppression Ratio (IHF)	60 dB
Capture Ratio (IHF)	AUTO DX 2.5 dB.
Alternate Channel Selectivity (IHF)	DX 90 dB
Signal to Noise Ratio (at 85dBf) Mono	88 dB
Stereo	84 dB
Distortion Mono	100Hz Local 0.04%
	1kHz Local 0.05%
	6kHz Local 0.08%
Stereo	100Hz Local 0.05%
	1kHz Local 0.05%
	6kHz Local 0.08%

Stereo Separation

100Hz	Local 60 dB
1kHz	Local 58 dB
10kHz	Local 45 dB

Frequency Response

50Hz to 10kHz	\pm 0.5 dB
30Hz to 15kHz	+0.3 -1.0 dB

Subcarrier Product Ratio . 50 dB

Auto-DX Switching

Threshold 40 μ V (37.3 dBf)

AM SECTION

Tuning Range	516 to 1614kHz
Usable Sensitivity (IHF)	10 μ V
Selectivity	25 dB
Signal to Noise Ratio	50 dB
Image Response Ratio	40 dB
Spurious Response Ratio	Better than 50 dB
Distortion (400Hz)	0.4%

AUDIO SECTION

Output Level/Impedance FM (100% mod. 1kHz)	500mV/5k Ω
AM (30% mod. 400Hz)	150mV/5k Ω
Rec Cal Signal (333Hz: Corresponding to 50% FM modulation)	250mV/5k Ω

GENERAL

Power Supply	120V, 60Hz
Power Consumption	12W
Dimensions (WxHxD)	435x72x318.5mm (17-1/8"x2-7/8"x12-5/8")
Weight	3.8 kg (8.4 lbs)

Specifications subject to change without notice.

T-960II

TROUBLESHOOTING

Before assuming that your tuner is faulty, check the following troubleshooting list which details corrective action you can take yourself without having to call a service engineer. If you have any doubts or questions, get in touch with your nearest Yamaha dealer.

	Fault	Cause	Cure
FM	Crackling sounds from time to time (especially in weak signal areas).	Ignition noise from vehicles.	The FM antenna should be put up as high as possible, away from the road, and a coaxial cable used.
		Noise from thermostats or other electrical equipment.	Attach a noise suppressor to the equipment causing the noise.
	The FM stereo reception is noisy.	Because of the characteristics of FM stereo broadcasts, this is limited to cases where the transmitter is far away or the antenna input is poor.	Check the antenna connections.
			Try using a multiple element FM antenna.
			Set the TUNING MODE switch to the "MAN'L FM MONO" position.
	The FM Stereo indicator flickers on and off and reception is noisy.	Insufficient antenna input.	Use an antenna appropriate for the reception conditions in your area.
		Not tuned correctly.	Tune again.
	There is distortion and clear reception can not be obtained even with a good FM antenna.	There is multipath interference.	Adjust antenna placement to eliminate multipath interference.
Sounds from the left leak to the right.	A certain amount of crosstalk is normal.	If the effect is small, there is no trouble.	
A desired station can not be tuned in with Auto Tuning.	The station is too weak.	Use a high-quality directional FM antenna.	
		Use Manual tuning mode.	
AM	Insufficient sensitivity.	Weak signal or loose antenna connections.	Tighten the AM loop antenna connections and rotate it for best reception.
			Use an outdoor antenna.
	There are continuous crackling and hissing noises.	These noises result from lightning, fluorescent lamps, motors, thermostats and other electrical equipment.	Use an outdoor antenna and a groundwire. This will help somewhat but it is difficult to eliminate all noise.
	There are buzzing and whining noises (especially in the evening).	Another station is interfering with the received station.	This is impossible to remedy.
A television set is being used nearby.		Move the television a distance away.	

BLOCK DIAGRAM

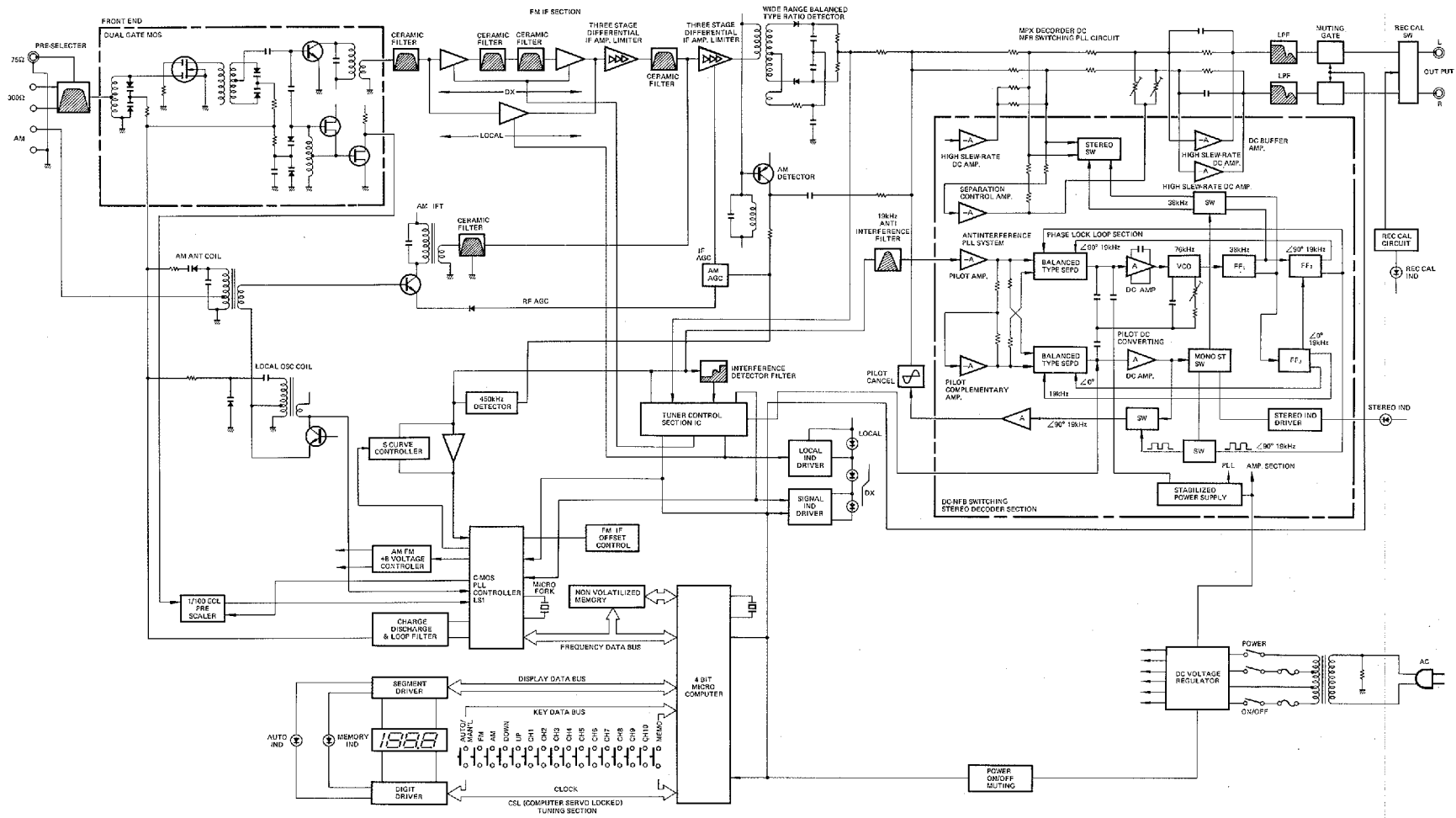

SINCE 1887  **YAMAHA**
NIPPON GAKKI CO., LTD. HAMAMATSU, JAPAN